



CE65H160DNDI

## CoreGaN 650V GaN HEMT

### Description

The CE65H160DNDI Series 650V, 160mΩ gallium nitride (GaN) FETs are normally-off devices.

Coreenergy GaN FETs offer better efficiency through lower gate charge, faster switching speeds, and lower dynamic on-resistance, delivering significant advantages over traditional silicon (Si) devices.

Coreenergy is a leading-edge wide band gap supplier with world-class innovation .

### Application

- Adapter
- Renewable energy
- Telecom and data-com
- Servo motors
- Industrial
- Automotive

### General Features

Easy to drive—compatible with standard gate drivers  
 Low conduction and switching losses  
 RoHS compliant and Halogen-free

### Benefits

Increased efficiency through fast switching  
 Increased power density  
 Reduced system size and weight

### Ordering Information

Part Number	Package	Package Configuration
CE65H160DNDI	DFN 8*8	Source

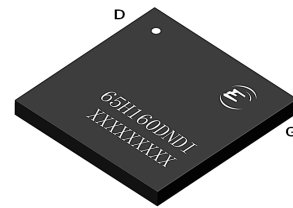

Top

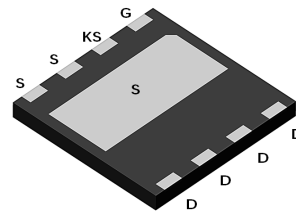

Bottom

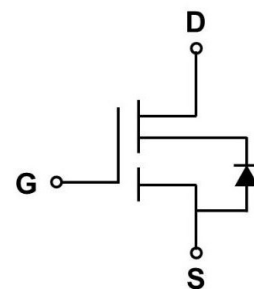

Circuit Symbol

### Features

$BV_{DSS}$	$R_{DS(on)}$	$I_{DS}$	$Q_G$
650V	160mΩ	14.5A	7.4nC



## Absolute Maximum Ratings

$T_c=25^\circ\text{C}$  unless otherwise stated

Symbol	Parameter		Limit value	Unit
$V_{DSS}$	Drain to source voltage ( $T_J = -55^\circ\text{C}$ to $150^\circ\text{C}$ )		650	
$V_{(TR)DSS}$	Drain to source voltage-transient <sup>a</sup>		800	V
$V_{GSS}$	Gate to source voltage		-20~+20	
$I_D$	Continuous drain current @ $T_c=25^\circ\text{C}$ <sup>b</sup>		14.5	A
	Continuous drain current @ $T_c=125^\circ\text{C}$ <sup>b</sup>		6.4	
$I_{DM}$	Pulse drain current (pulse width: 10 $\mu\text{s}$ )		27	A
$P_D$	Maximum power dissipation @ $T_c=25^\circ\text{C}$		89	W
$T_c$	Operating temperature	Case	-55~150	$^\circ\text{C}$
$T_J$		Junction	-55~150	$^\circ\text{C}$
$T_S$	Storage temperature		-55~150	$^\circ\text{C}$

a. In off-state, spike duty cycle  $D < 0.01$ , spike duration  $< 1\mu\text{s}$

b. For increased stability at high current operation



## Thermal Resistance

Symbol	Parameter	Limit value	Unit
$R_{\theta JC}$	Junction-to-case	1.4	$^{\circ}\text{C} / \text{W}$



## Electrical Parameters

T<sub>J</sub>=25°C unless otherwise stated

Symbol	Parameter	Min	Typ	Max	Unit	Test Conditions
<b>Forward Device Characteristics</b>						
V <sub>(BL)DSS</sub>	Drain-source voltage	650	-	-	V	V <sub>GS</sub> = 0V
V <sub>GS(th)</sub>	Gate threshold voltage	3.3	3.9	4.5	V	V <sub>DS</sub> =1V, I <sub>DS</sub> =1mA
ΔV <sub>GS(th)</sub> /T <sub>J</sub>	Gate threshold voltage temperature coefficient	-	-7	-	mV/°C	
R <sub>DS(on)</sub>	Drain-source on-Resistance	-	160	200	mΩ	V <sub>GS</sub> =10V, I <sub>D</sub> =1A, T <sub>J</sub> =25°C
		-	350	-		V <sub>GS</sub> =10V, I <sub>D</sub> =1A, T <sub>J</sub> =150°C
I <sub>DSS</sub>	Drain-to-source leakage current	-	1	10	μA	V <sub>DS</sub> =650V, V <sub>GS</sub> = 0V, T <sub>J</sub> =25°C
		-	5	100		V <sub>DS</sub> =650V, V <sub>GS</sub> = 0V, T <sub>J</sub> =150°C
I <sub>GSS</sub>	Gate-to-source forward leakage current	-	-	±100	nA	V <sub>GS</sub> =±20V
C <sub>ISS</sub>	Input capacitance	-	329	-	pF	V <sub>GS</sub> =0V, V <sub>DS</sub> =400V, f=1MHz
C <sub>OSS</sub>	Output capacitance	-	25	-		
C <sub>RSS</sub>	Reverse capacitance	-	1	-		
Q <sub>G</sub>	Total gate charge	-	7.4	-	nC	V <sub>DS</sub> =400V, V <sub>GS</sub> =0V to 10V, I <sub>D</sub> =1A
Q <sub>GS</sub>	Gate-source charge	-	2.6	-		
Q <sub>GD</sub>	Gate-drain charge	-	1.8	-		
Q <sub>OSS</sub>	Output charge	-	34	-	nC	V <sub>GS</sub> =0V, V <sub>DS</sub> =0V to 400V, f=1MHz
t <sub>D(on)</sub>	Turn-on delay	-	3.3	-	ns	V <sub>DS</sub> =400V, V <sub>GS</sub> =0V to 10V, I <sub>D</sub> =2.1A, R <sub>G-on(ext)</sub> =6.8Ω, R <sub>G-off(ext)</sub> =2.2Ω, L=250μH
t <sub>R</sub>	Rise time	-	7	-		
t <sub>D(off)</sub>	Turn-off delay	-	9.8	-		
t <sub>F</sub>	Fall time	-	27	-		



## Electrical Parameters

T<sub>J</sub>=25°C unless otherwise stated

Symbol	Parameter	Min	Typ	Max	Unit	Test Conditions
<b>Reverse Device Characteristics</b>						
V <sub>SD</sub>	Source-Drain reverse voltage	-	2.5	-	V	V <sub>GS</sub> =0V, I <sub>SD</sub> =10A
t <sub>RR</sub>	Reverse recovery time	-	14	-	ns	I <sub>F</sub> =10A, V <sub>DD</sub> =400V, dI <sub>F</sub> /dt=165A/μs
Q <sub>RR</sub>	Reverse recovery charge	-	6.5	-	nC	



### Typical Characteristics

T<sub>J</sub>=25°C unless otherwise stated

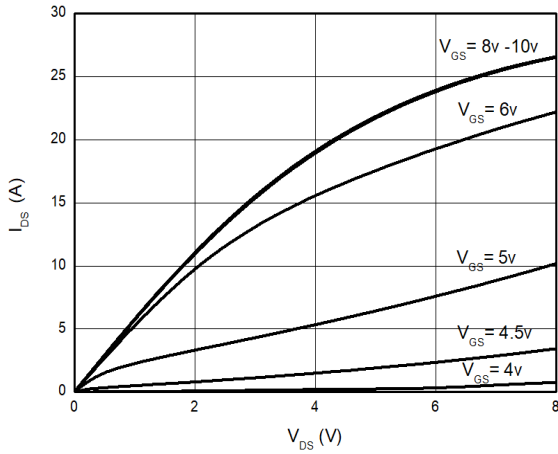

Figure 1. Typical Output Characteristics T<sub>J</sub>=25°C

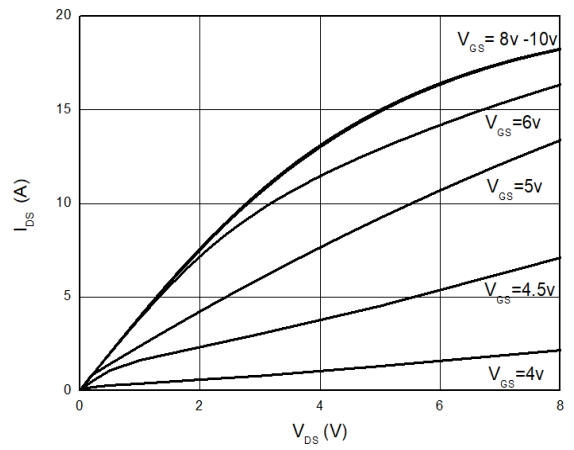

Figure 2. Typical Output Characteristics T<sub>J</sub>=125°C

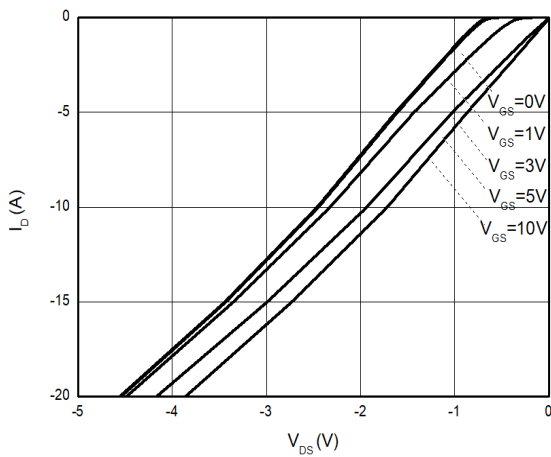

Figure 3. Channel Reverse Characteristics T<sub>J</sub>=25°C

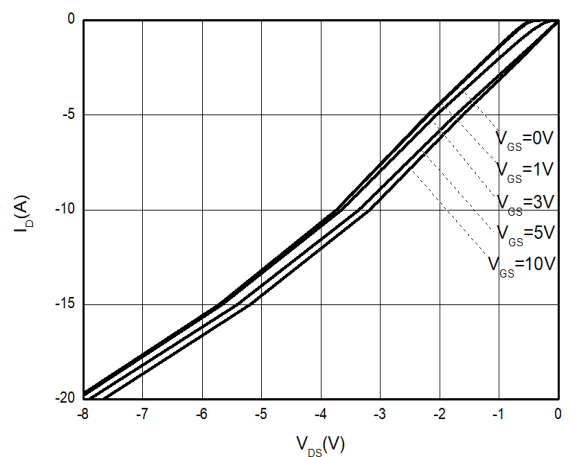

Figure 4. Channel Reverse Characteristics T<sub>J</sub>=125°C



### Typical Characteristics

$T_J=25^\circ\text{C}$  unless otherwise stated

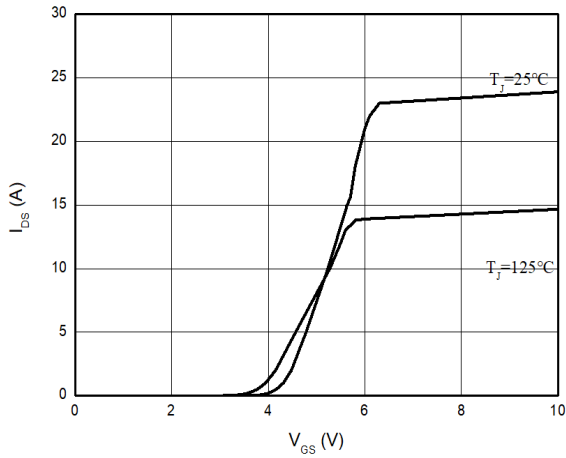

Figure 5. Typical Transfer Characteristics ( $V_{DS}=5V$ )

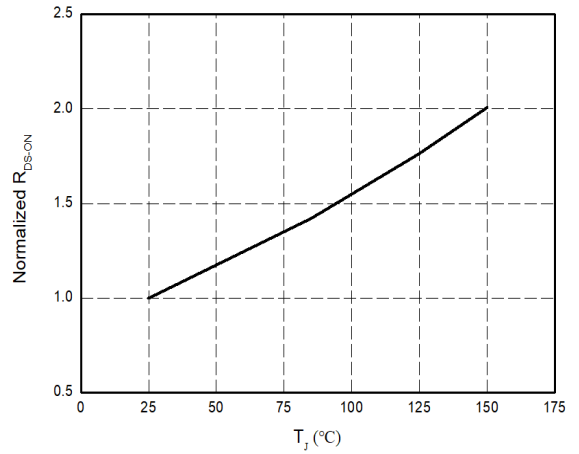

Figure 6. Normalized On-resistance

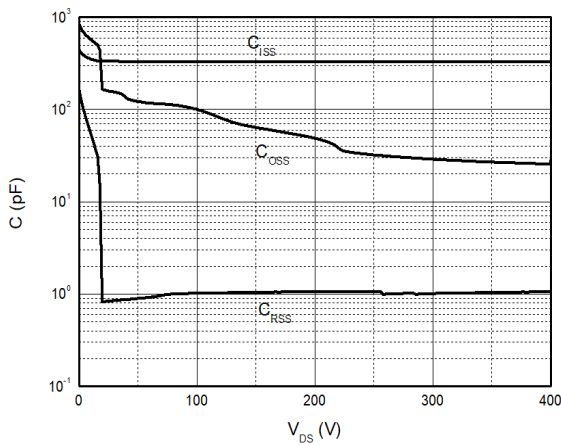

Figure 7. Typical Capacitance ( $f=1\text{MHz}$ )

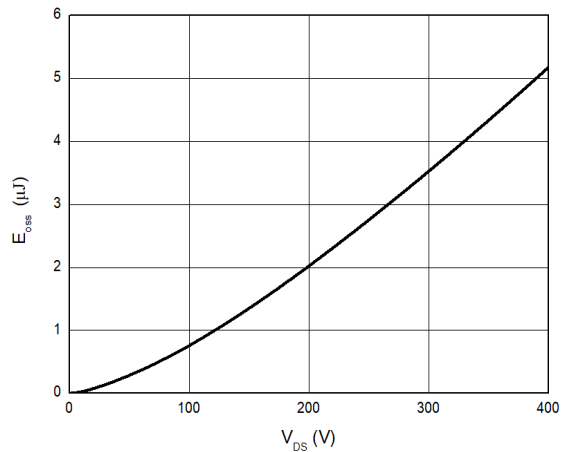

Figure 8. Typical  $C_{OSS}$  Stored Energy



### Typical Characteristics

$T_J=25^\circ\text{C}$  unless otherwise stated

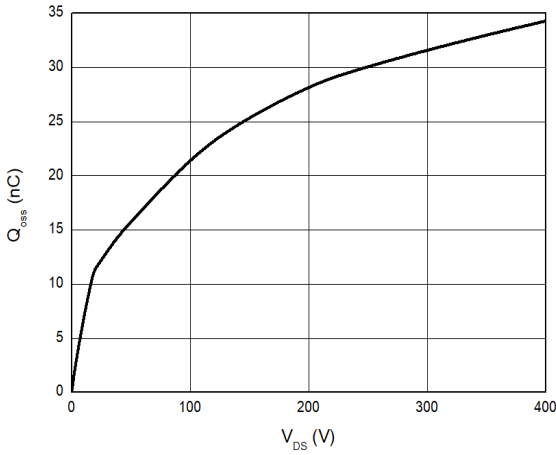

Figure 9. Typical  $Q_{oss}$

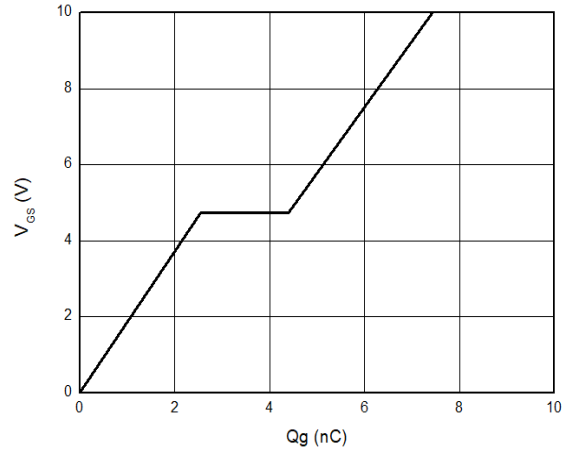

Figure 10. Typical Gate Charge ( $V_{DS}=400\text{V}$ ,  $I_D=1\text{A}$ )

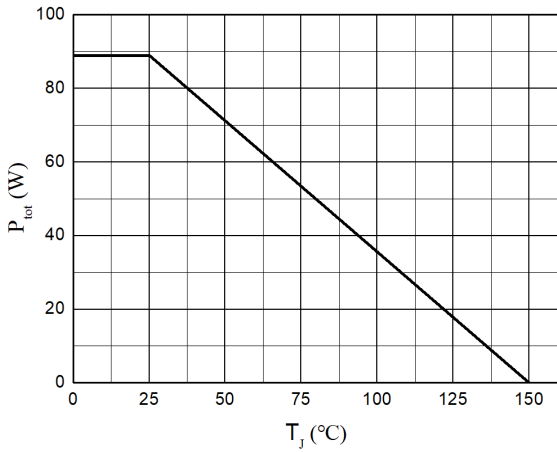

Figure 11. Power Dissipation

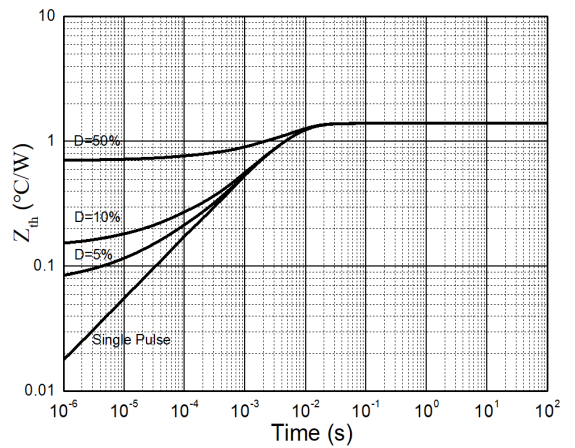

Figure 12. Transient Thermal Resistance



### Typical Characteristics

$T_J=25^\circ\text{C}$  unless otherwise stated

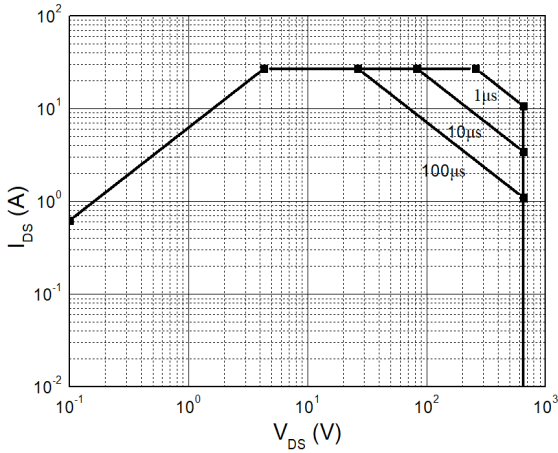

Figure 13. Safe Operating Area  $T_c=25^\circ\text{C}$

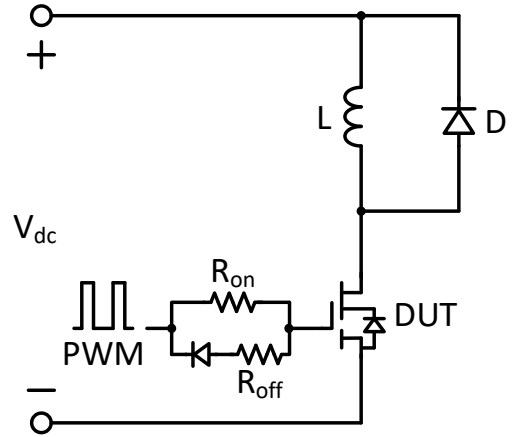

Figure 14. Switching times with inductive load

$V_{DS}=400\text{V}$ ,  $V_{GS}=0\text{V to }10\text{V}$ ,  $I_D=2.1\text{A}$ ,  
 $R_{G-on(ext)}=6.8\Omega$ ,  $R_{G-off(ext)}=2.2\Omega$ ,  $L=250\mu\text{H}$

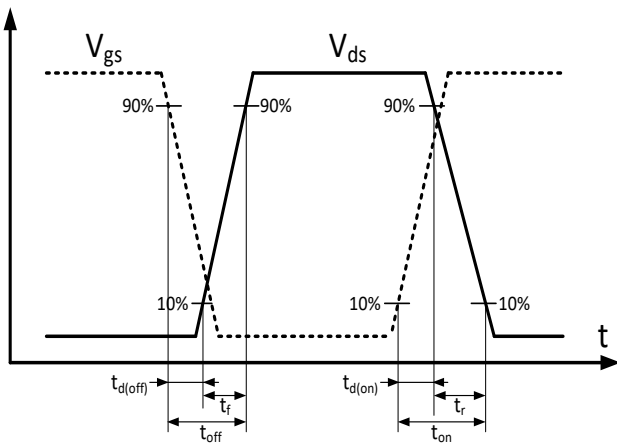
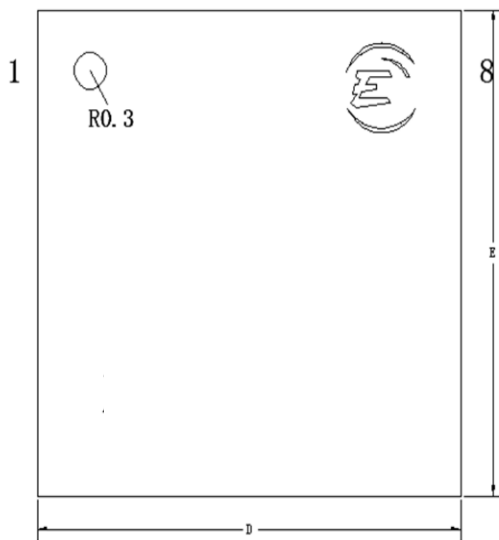

Figure 15. Switching times with waveform

**PACKAGE DIMENSIONS**

DFN8x8-8L-1.10-A

Top view



Bottom view

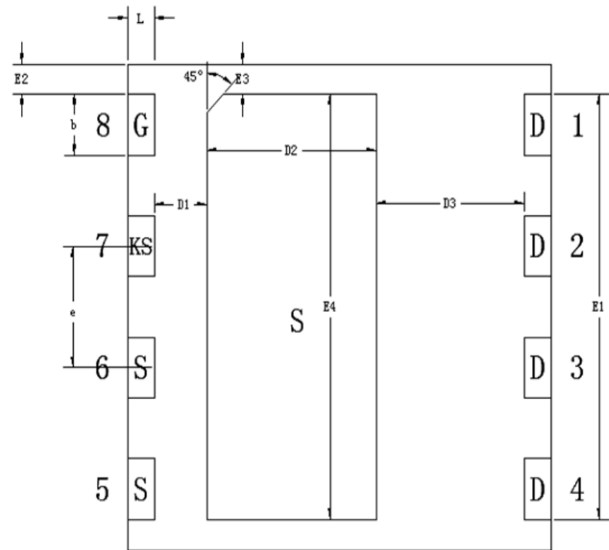

Side view(left/right)

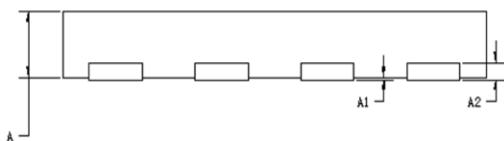

Symbol	Min. (mm)	Mean. (mm)	Max. (mm)
A	1.05	1.10	1.15
A1	0	0.02	0.05
A2	0.203REF		
D	7.9	8	8.1
E	7.9	8	8.1
D1	0.9	1	1.1
D2	3.1	3.2	3.3
D3	2.7	2.8	2.9
E1	6.9	7	7.1
E2	0.4	0.5	0.6
E3	0.4	0.5	0.6
E4	6.9	7	7.1
e	1.9	2	2.1
b	0.9	1	1.1
L	0.4	0.5	0.6



## Revision history

### Major changes since the last revision

Revision	Date	Description of changes
1.0	2022-02-28	Initial release
2.0	2024-06-01	Enrich dynamic specification curves