



CE65H450TOEI

CoreGaN 650V GaN HEMT

Description

The CE65H450TOEI Series 650V, 450mΩ gallium nitride (GaN) FETs are normally-off devices.

Coreenergy GaN FETs offer better efficiency through lower gate charge, faster switching speeds, and lower dynamic on-resistance, delivering significant advantages over traditional silicon (Si) devices.

Coreenergy is a leading-edge wide band gap supplier with world-class innovation .

Application

- Adapter
- Renewable energy
- Telecom and data-com
- Servo motors
- Industrial
- Automotive

General Features

Easy to drive—compatible with standard gate drivers
 Low conduction and switching losses
 RoHS compliant and Halogen-free

Benefits

Increased efficiency through fast switching
 Increased power density
 Reduced system size and weight

Ordering Information

Part Number	Package	Package Configuration
CE65H450TOEI	TO252	Source

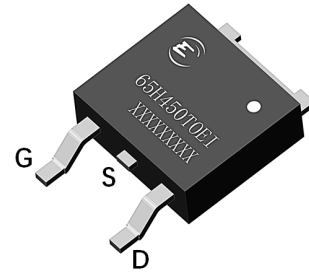

Top

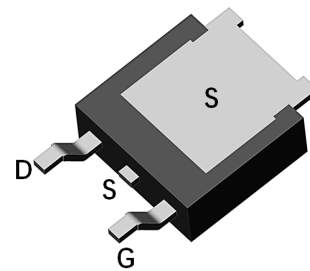

Bottom

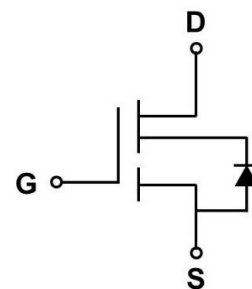

Circuit Symbol

Features

BV_{DSS}	$R_{DS(ON)}$	I_{DS}	Q_G
650V	450mΩ	7A	7.6nC



Absolute Maximum Ratings

$T_c=25^\circ\text{C}$ unless otherwise stated

Symbol	Parameter	Limit value	Unit	
V_{DSS}	Drain to source voltage ($T_J = -55^\circ\text{C}$ to 150°C)	650		
$V_{(TR)DSS}$	Drain to source voltage-transient ^a	800	V	
V_{GSS}	Gate to source voltage	-20~+20		
I_D	Continuous drain current @ $T_c=25^\circ\text{C}$ ^b	7	A	
	Continuous drain current @ $T_c=125^\circ\text{C}$ ^b	3		
I_{DM}	Pulse drain current (pulse width: 10 μs)	10.5	A	
P_D	Maximum power dissipation @ $T_c=25^\circ\text{C}$	52	W	
T_c	Operating temperature	Case	-55~150	$^\circ\text{C}$
T_J		Junction	-55~150	$^\circ\text{C}$
T_S	Storage temperature	-55~150	$^\circ\text{C}$	

a. In off-state, spike duty cycle $D < 0.01$, spike duration $< 1\mu\text{s}$

b. For increased stability at high current operation



Thermal Resistance

Symbol	Parameter	Limit value	Unit
$R_{\theta JC}$	Junction-to-case	2.4	$^{\circ}\text{C} / \text{W}$



Electrical Parameters

$T_J=25^\circ\text{C}$ unless otherwise stated

Symbol	Parameter	Min	Typ	Max	Unit	Test Conditions
Forward Device Characteristics						
$V_{(BL)DSS}$	Drain-source voltage	650	-	-	V	$V_{GS}=0V$
$V_{GS(th)}$	Gate threshold voltage	3.3	3.9	4.5	V	$V_{DS}=1V, I_{DS}=1mA$
$\Delta V_{GS(th)}/T_J$	Gate threshold voltage temperature coefficient	-	-7	-	mV/ $^\circ\text{C}$	
$R_{DS(on)}$	Drain-source on-Resistance	-	450	520	m Ω	$V_{GS}=10V, I_D=1A, T_J=25^\circ\text{C}$
		-	940	-		$V_{GS}=10V, I_D=1A, T_J=150^\circ\text{C}$
I_{DSS}	Drain-to-source leakage current	-	2	10	μA	$V_{DS}=650V, V_{GS}=0V, T_J=25^\circ\text{C}$
		-	5	100		$V_{DS}=650V, V_{GS}=0V, T_J=150^\circ\text{C}$
I_{GSS}	Gate-to-source forward leakage current	-	-	± 100	nA	$V_{GS}=\pm 20V$
C_{ISS}	Input capacitance	-	335	-	pF	$V_{GS}=0V, V_{DS}=400V, f=1MHz$
C_{OSS}	Output capacitance	-	11	-		
C_{RSS}	Reverse capacitance	-	0.9	-		
Q_G	Total gate charge	-	7.6	-	nC	$V_{DS}=400V, V_{GS}=0V \text{ to } 10V, I_D=1A$
Q_{GS}	Gate-source charge	-	2.3	-		
Q_{GD}	Gate-drain charge	-	2.8	-		
Q_{OSS}	Output charge	-	17	-	nC	$V_{GS}=0V, V_{DS}=0V \text{ to } 400V, f=1MHz$
$t_{D(on)}$	Turn-on delay	-	3.2	-	ns	$V_{DS}=400V, V_{GS}=0V \text{ to } 10V, I_D=2.1A,$ $R_{G-on(ext)}=6.8\Omega, R_{G-off(ext)}=2.2\Omega,$ $L=250\mu H$
t_R	Rise time	-	5.5	-		
$t_{D(off)}$	Turn-off delay	-	7.4	-		
t_F	Fall time	-	27	-		



Electrical Parameters

$T_j=25^\circ\text{C}$ unless otherwise stated

Symbol	Parameter	Min	Typ	Max	Unit	Test Conditions
Reverse Device Characteristics						
V_{SD}	Source-Drain reverse voltage	-	2.2	-	V	$V_{GS}=0\text{V}$, $I_{SD}=3.5\text{A}$
t_{RR}	Reverse recovery time	-	14	-	ns	$I_F=2.5\text{A}$, $V_{DD}=400\text{V}$, $dI_F/dt=165\text{A}/\mu\text{s}$
Q_{RR}	Reverse recovery charge	-	6.5	-	nC	



Typical Characteristics

$T_j=25^{\circ}\text{C}$ unless otherwise stated

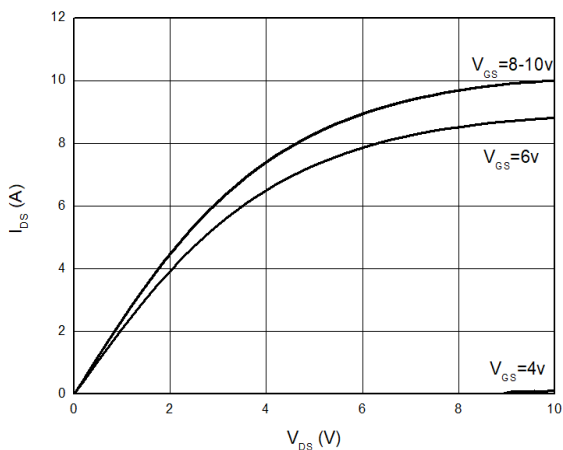

Figure 1. Typical Output Characteristics $T_j=25^{\circ}\text{C}$

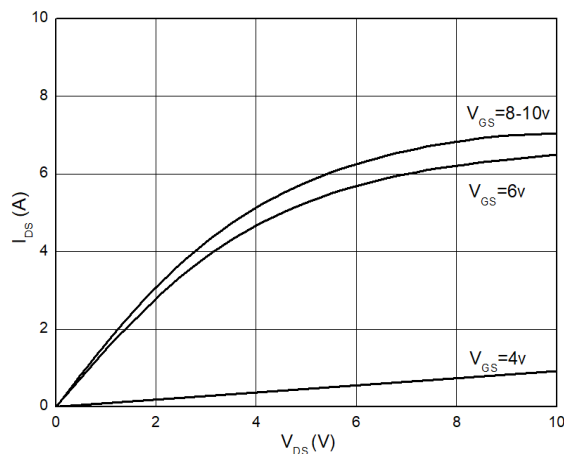

Figure 2. Typical Output Characteristics $T_j=125^{\circ}\text{C}$

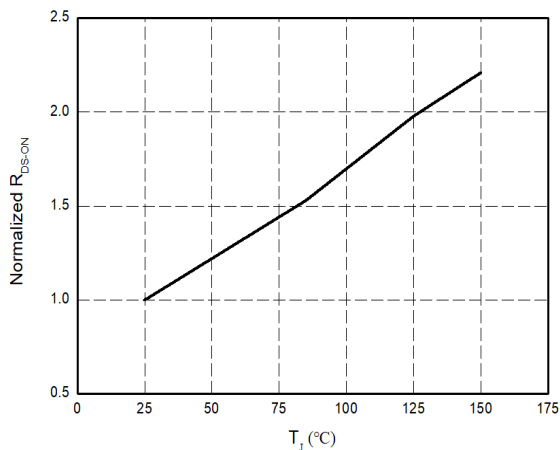

Figure 3. Normalized On-resistance

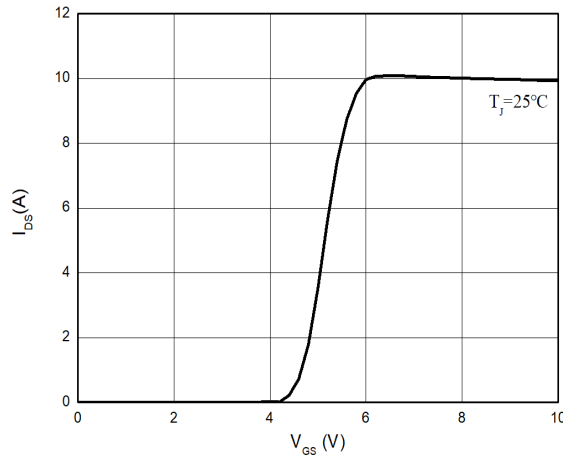

Figure 4. Typical Transfer Characteristics $T_j=25^{\circ}\text{C}$



Typical Characteristics

$T_j=25^\circ\text{C}$ unless otherwise stated

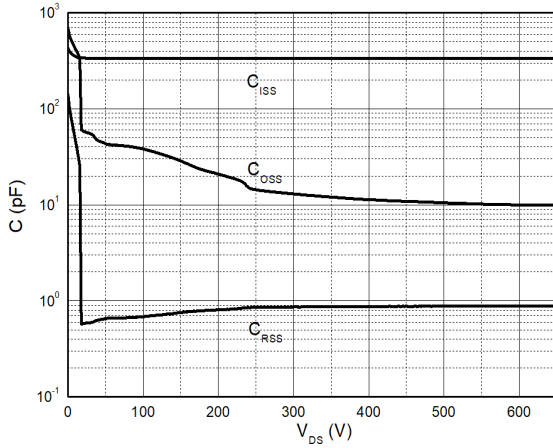

Figure 5. Typical Capacitance (f=1MHz)

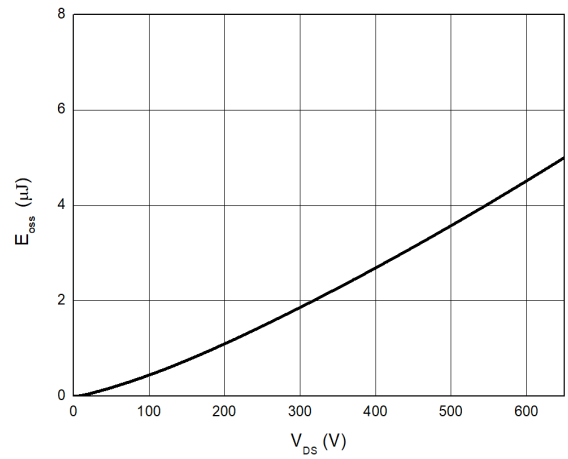

Figure 6. Typical C_{OSS} Stored Energy

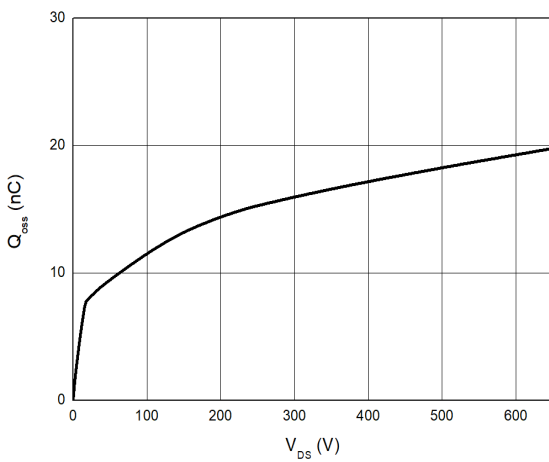

Figure 7. Typical Q_{OSS}

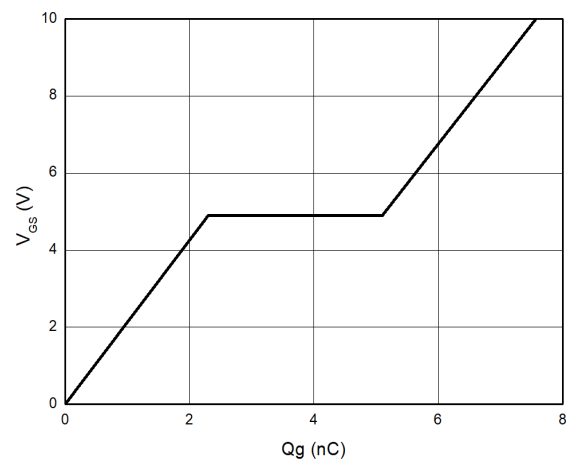

Figure 8. Typical Gate Charge ($V_{DS}=400\text{V}$, $I_D=1\text{A}$)



Typical Characteristics

$T_j=25^\circ\text{C}$ unless otherwise stated

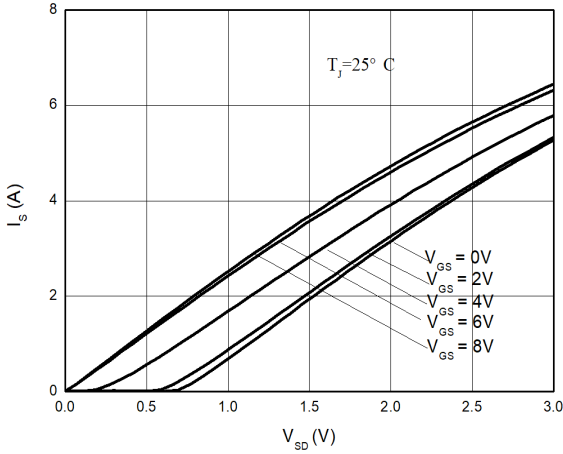

Figure 9. Channel Reverse Characteristics $T_j=25^\circ\text{C}$

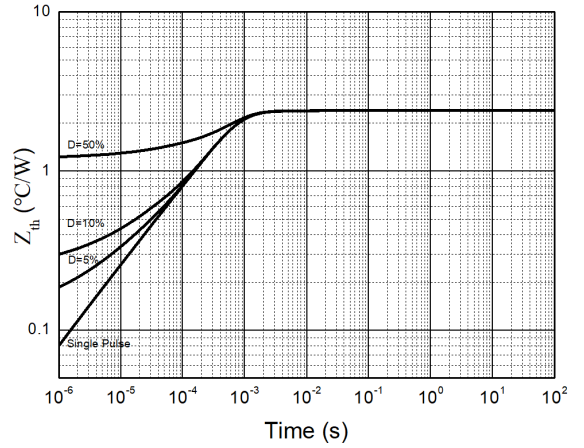

Figure 10. Transient Thermal Resistance

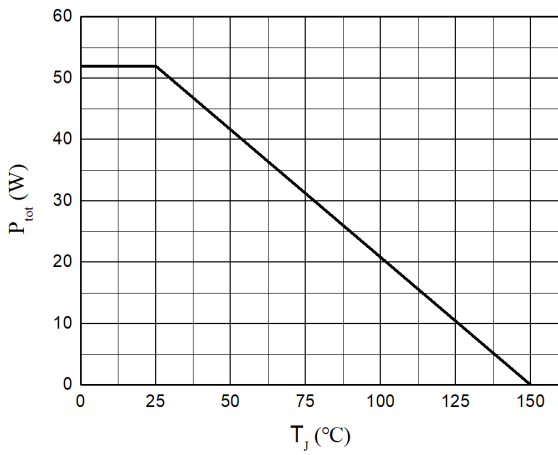

Figure 11. Power Dissipation

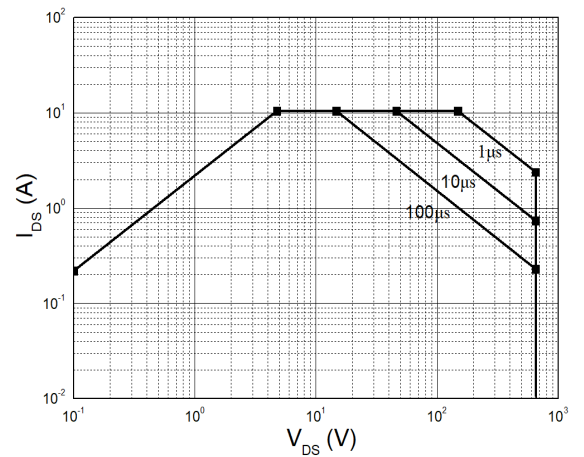

Figure 12. Safe Operating Area $T_j=25^\circ\text{C}$

Typical Characteristics

$T_j=25^\circ\text{C}$ unless otherwise stated

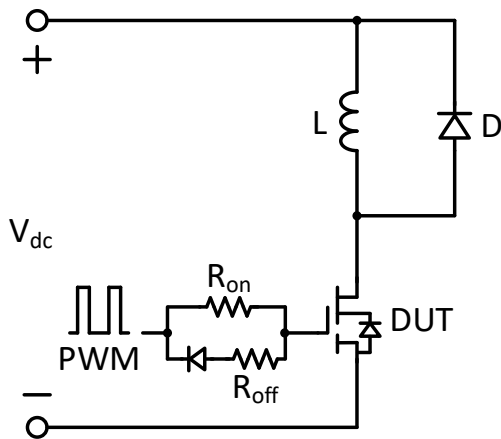

Figure 13. Switching times with inductive load

$V_{DS}=400\text{V}$, $V_{GS}=0\text{V}$ to 10V , $I_D=2.1\text{A}$,

$R_{G-on(ext)}=6.8\Omega$, $R_{G-off(ext)}=2.2\Omega$, $L=250\mu\text{H}$

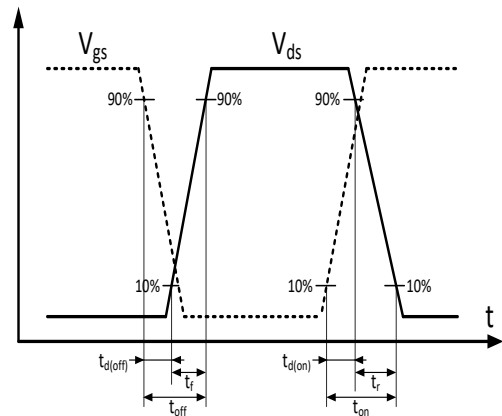
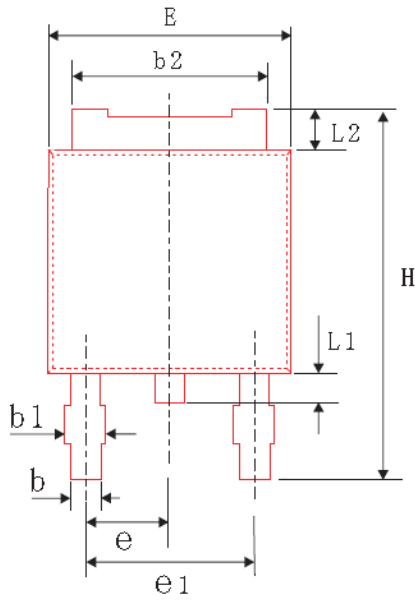
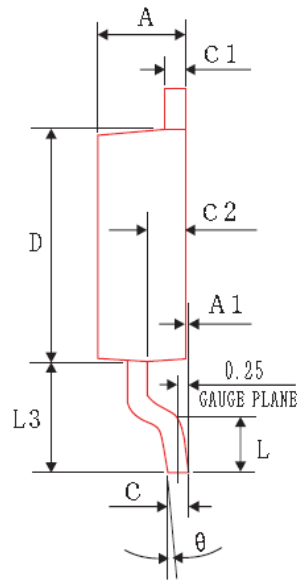

Figure 14. Switching times with waveform

PACKAGE DIMENSIONS



TOP VIEW



SIDE VIEW

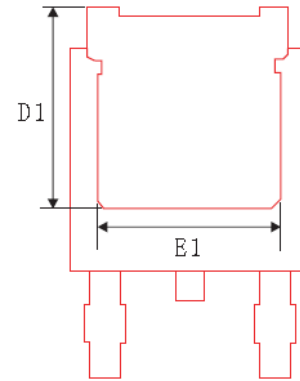

BOTTOM VIEW

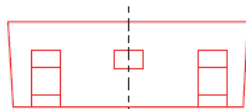

SIDE VIEW

COMMON DIMENSIONS
(UNITS OF MEASURE-mm)

SYMBOL	MIN	NOM	MAX
A	2.20	2.30	2.40
A1	0.00	0.05	0.10
b	0.762	0.812	0.862
b1	---	---	1.10
b2	5.23	5.33	5.43
c	0.458	0.508	0.558
c1	0.458	0.508	0.558
c2	0.80	1.00	1.20
D	6.00	6.10	6.20
D1	5.25	5.45	5.65
H	10.00	10.10	10.20
E	6.50	6.60	6.70
E1	4.75	4.85	4.95
e1	4.37	4.57	4.77
L	---	---	1.45
L1	0.60	0.75	0.90
L2	0.90	1.10	1.30
L3	2.80	3.00	3.20
θ	0°	4°	8°
e	2.285 BSC		



CE65H450TOEI

Revision history

Major changes since the last revision

Revision	Date	Description of changes
1.0	2024-05-06	Initial release