



CE65H270TOEI

CoreGaN 650V GaN HEMT

Description

The CE65H270TOEI Series 650V, 270mΩ gallium nitride (GaN) FETs are normally-off devices.

Coreenergy GaN FETs offer better efficiency through lower gate charge, faster switching speeds, and lower dynamic on-resistance, delivering significant advantages over traditional silicon (Si) devices.

Coreenergy is a leading-edge wide band gap supplier with world-class innovation .

Application

- Adapter
- Renewable energy
- Telecom and data-com
- Servo motors
- Industrial
- Automotive

General Features

Easy to drive—compatible with standard gate drivers
 Low conduction and switching losses
 RoHS compliant and Halogen-free

Benefits

Increased efficiency through fast switching
 Increased power density
 Reduced system size and weight

Ordering Information

| Part Number | Package | Package Configuration |
|--------------|---------|-----------------------|
| CE65H270TOEI | TO252 | Source |

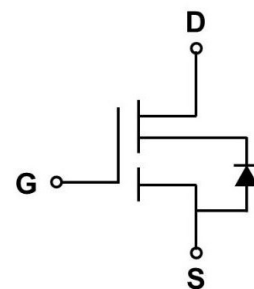
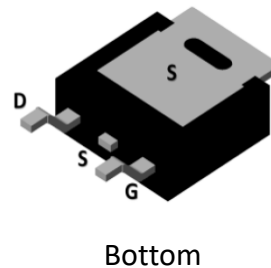
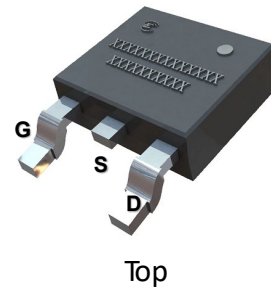

Circuit Symbol

Features

| BV_{DSS} | $R_{DS(on)}$ | I_{DS} | Q_G |
|------------|--------------|----------|-------|
| 650V | 270mΩ | 9.8A | 8.7nC |



Absolute Maximum Ratings

$T_c=25^\circ\text{C}$ unless otherwise stated

| Symbol | Parameter | Limit value | Unit | |
|---------------|--|-------------|------------------|------------------|
| V_{DSS} | Drain to source voltage ($T_J = -55^\circ\text{C}$ to 150°C) | 650 | | |
| $V_{(TR)DSS}$ | Drain to source voltage-transient ^a | 800 | V | |
| V_{GSS} | Gate to source voltage | -20~+20 | | |
| I_D | Continuous drain current @ $T_c=25^\circ\text{C}$ ^b | 9.8 | A | |
| | Continuous drain current @ $T_c=125^\circ\text{C}$ ^b | 4.7 | | |
| I_{DM} | Pulse drain current (pulse width: 10 μs) | 15 | A | |
| P_D | Maximum power dissipation @ $T_c=25^\circ\text{C}$ | 62 | W | |
| T_c | Operating temperature | Case | -55~150 | $^\circ\text{C}$ |
| T_J | | Junction | -55~150 | $^\circ\text{C}$ |
| T_S | Storage temperature | -55~150 | $^\circ\text{C}$ | |

a. In off-state, spike duty cycle $D < 0.01$, spike duration $< 1\mu\text{s}$

b. For increased stability at high current operation



Thermal Resistance

| Symbol | Parameter | Limit value | Unit |
|-----------------|------------------|-------------|-------|
| $R_{\theta JC}$ | Junction-to-case | 2 | °C /W |



Electrical Parameters

$T_J=25^\circ\text{C}$ unless otherwise stated

| Symbol | Parameter | Min | Typ | Max | Unit | Test Conditions |
|---------------------------------------|--|-----|-----|-----------|----------------------|--|
| Forward Device Characteristics | | | | | | |
| $V_{(BL)DSS}$ | Drain-source voltage | 650 | - | - | V | $V_{GS}=0\text{V}$ |
| $V_{GS(th)}$ | Gate threshold voltage | 3.3 | 3.9 | 4.5 | V | $V_{DS}=1\text{V}, I_{DS}=1\text{mA}$ |
| $\Delta V_{GS(th)}/T_J$ | Gate threshold voltage temperature coefficient | - | -7 | - | mV/ $^\circ\text{C}$ | |
| $R_{DS(on)}$ | Drain-source on-Resistance | - | 270 | 320 | m Ω | $V_{GS}=10\text{V}, I_D=1\text{A}, T_J=25^\circ\text{C}$ |
| | | - | 570 | - | | $V_{GS}=10\text{V}, I_D=1\text{A}, T_J=150^\circ\text{C}$ |
| I_{DSS} | Drain-to-source leakage current | - | 1 | 10 | μA | $V_{DS}=650\text{V}, V_{GS}=0\text{V}, T_J=25^\circ\text{C}$ |
| | | - | 5 | 100 | | $V_{DS}=650\text{V}, V_{GS}=0\text{V}, T_J=150^\circ\text{C}$ |
| I_{GSS} | Gate-to-source forward leakage current | - | - | ± 100 | nA | $V_{GS}=\pm 20\text{V}$ |
| C_{ISS} | Input capacitance | - | 333 | - | pF | $V_{GS}=0\text{V}, V_{DS}=400\text{V}, f=1\text{MHz}$ |
| C_{OSS} | Output capacitance | - | 18 | - | | |
| C_{RSS} | Reverse capacitance | - | 3.7 | - | | |
| Q_G | Total gate charge | - | 8.7 | - | nC | $V_{DS}=400\text{V}, V_{GS}=0\text{V to }10\text{V}, I_D=1\text{A}$ |
| Q_{GS} | Gate-source charge | - | 2.2 | - | | |
| Q_{GD} | Gate-drain charge | - | 2.6 | - | | |
| Q_{OSS} | Output charge | - | 24 | - | nC | $V_{GS}=0\text{V}, V_{DS}=0\text{V to }400\text{V}, f=1\text{MHz}$ |
| $t_{D(on)}$ | Turn-on delay | - | 3.2 | - | ns | $V_{DS}=400\text{V}, V_{GS}=0\text{V to }10\text{V}, I_D=2.1\text{A},$ $R_{G-on(ext)}=6.8\Omega, R_{G-off(ext)}=2.2\Omega,$ $L=250\mu\text{H}$ |
| t_R | Rise time | - | 5.5 | - | | |
| $t_{D(off)}$ | Turn-off delay | - | 7.4 | - | | |
| t_F | Fall time | - | 27 | - | | |



Electrical Parameters

$T_j=25^{\circ}\text{C}$ unless otherwise stated

| Symbol | Parameter | Min | Typ | Max | Unit | Test Conditions |
|---------------------------------------|------------------------------|-----|-----|-----|------|--|
| Reverse Device Characteristics | | | | | | |
| V_{SD} | Source-Drain reverse voltage | - | 2.3 | - | V | $V_{GS}=0\text{V}$, $I_{SD}=5\text{A}$ |
| t_{RR} | Reverse recovery time | - | 14 | - | ns | $I_F=5\text{A}$, $V_{DD}=400\text{V}$, $dI_F/dt=165\text{A}/\mu\text{s}$ |
| Q_{RR} | Reverse recovery charge | - | 6.5 | - | nC | |



Typical Characteristics

$T_j=25^\circ\text{C}$ unless otherwise stated

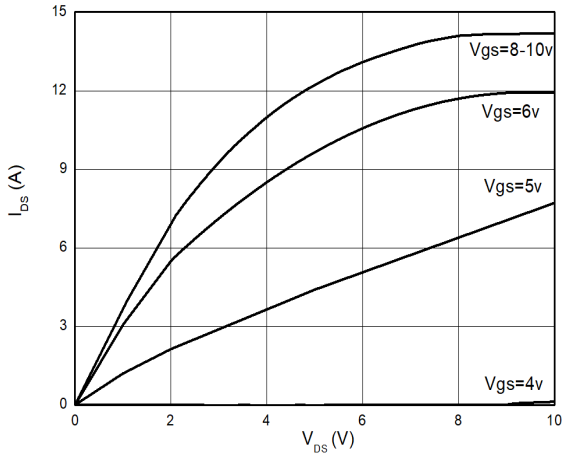

Figure 1. Typical Output Characteristics $T_j=25^\circ\text{C}$

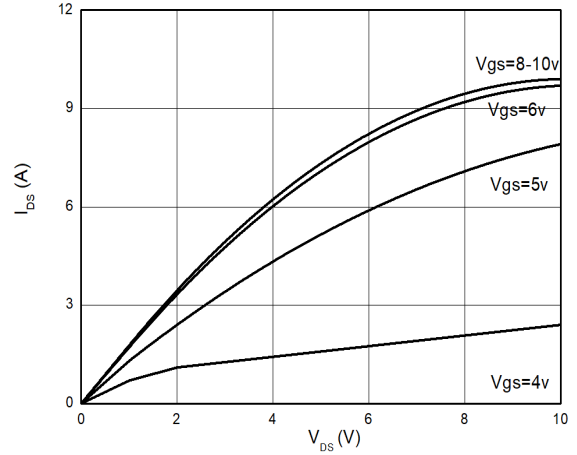

Figure 2. Typical Output Characteristics $T_j=125^\circ\text{C}$

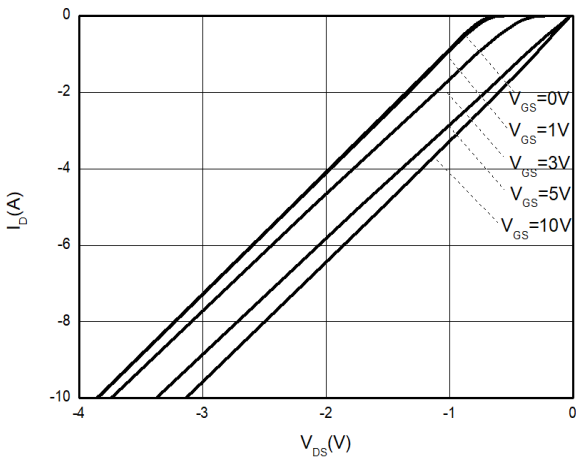

Figure 3. Channel Reverse Characteristics $T_j=25^\circ\text{C}$

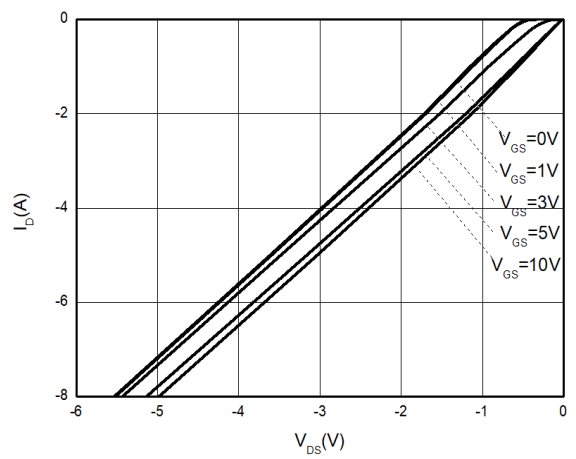

Figure 4. Channel Reverse Characteristics $T_j=125^\circ\text{C}$



Typical Characteristics

$T_j=25^\circ\text{C}$ unless otherwise stated

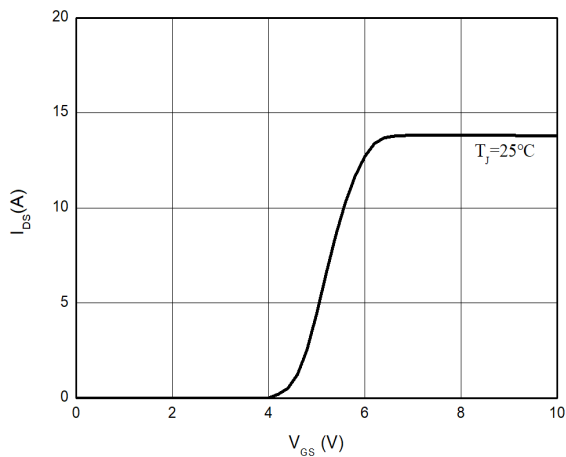

Figure 5. Typical Transfer Characteristics (V_{DS}=10V)

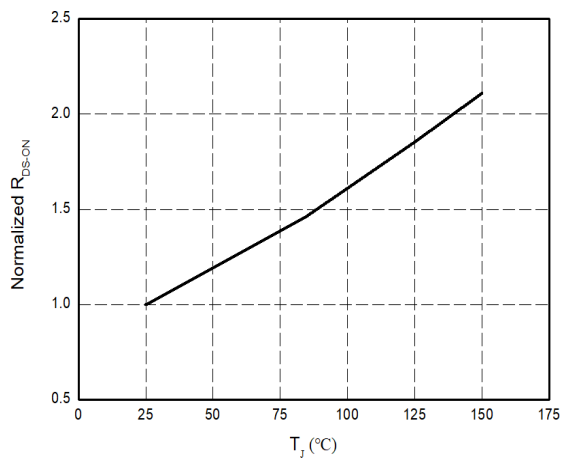

Figure 6. Normalized On-resistance

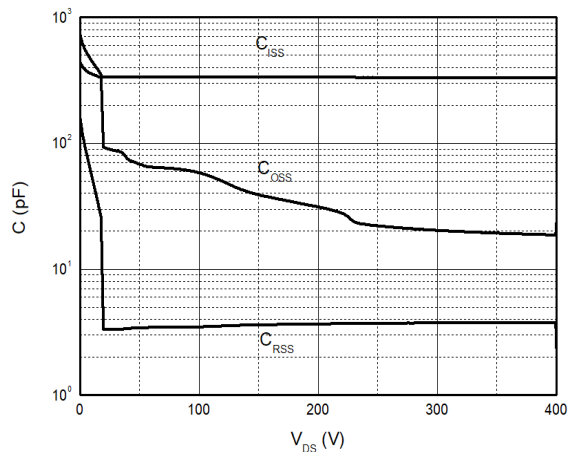

Figure 7. Typical Capacitance (f=1MHz)

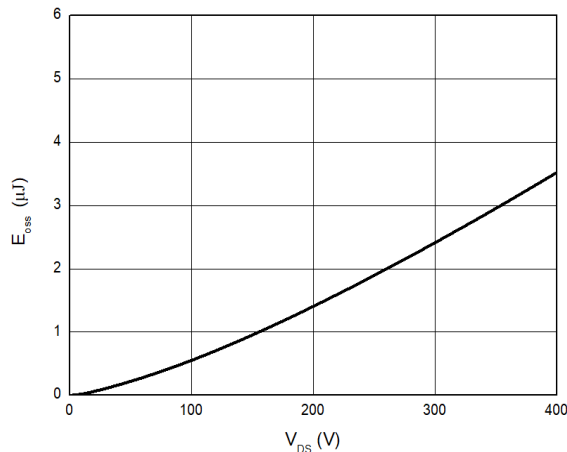

Figure 8. Typical C_{oss} Stored Energy



Typical Characteristics

$T_j=25^\circ\text{C}$ unless otherwise stated

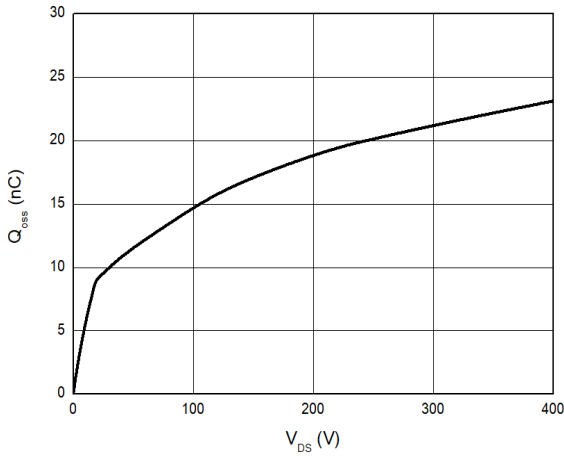

Figure 9. Typical Q_{oss}

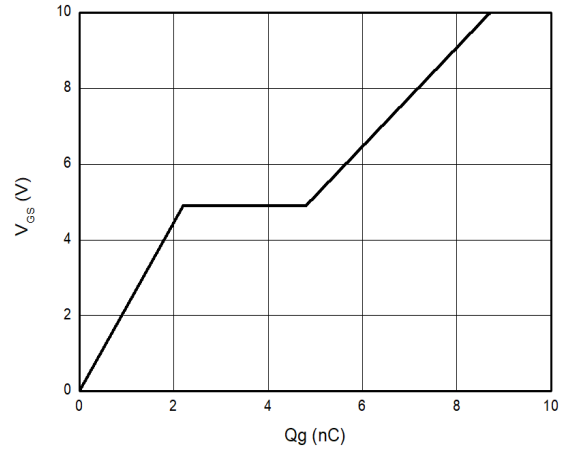

Figure 10. Typical Gate Charge ($V_{DS}=400\text{V}$, $I_D=1\text{A}$)

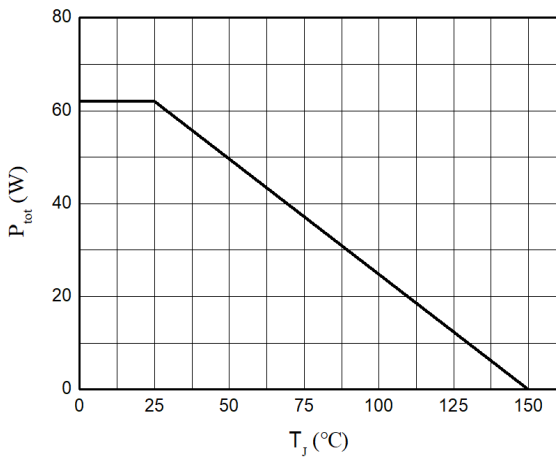

Figure 11. Power Dissipation

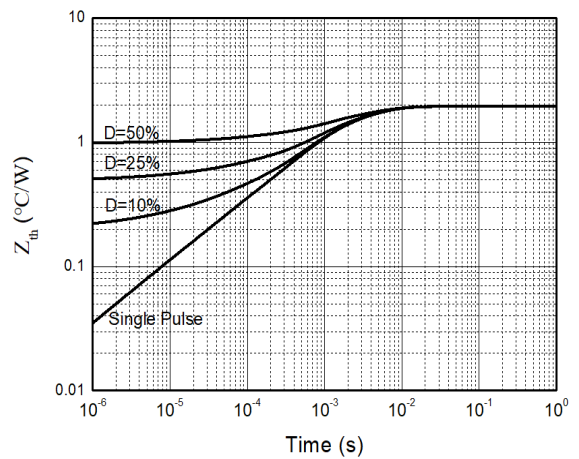

Figure 12. Transient Thermal Resistance

Typical Characteristics

$T_j=25^\circ\text{C}$ unless otherwise stated

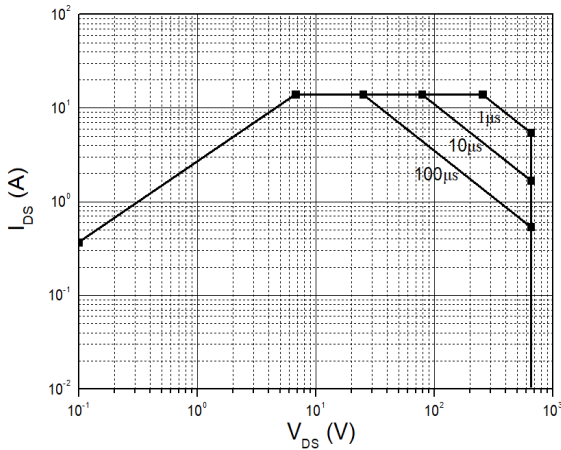

Figure 13. Safe Operating Area $T_c=25^\circ\text{C}$

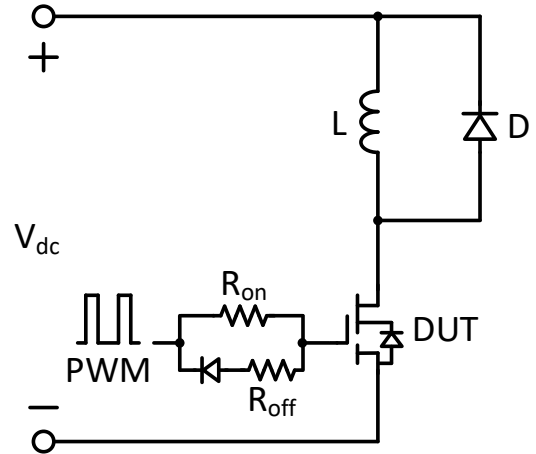

Figure 14. Switching times with inductive load

$V_{DS}=400\text{V}$, $V_{GS}=0\text{V}$ to 10V , $I_D=2.1\text{A}$,
 $R_{G-on(ext)}=6.8\Omega$, $R_{G-off(ext)}=2.2\Omega$, $L=250\mu\text{H}$

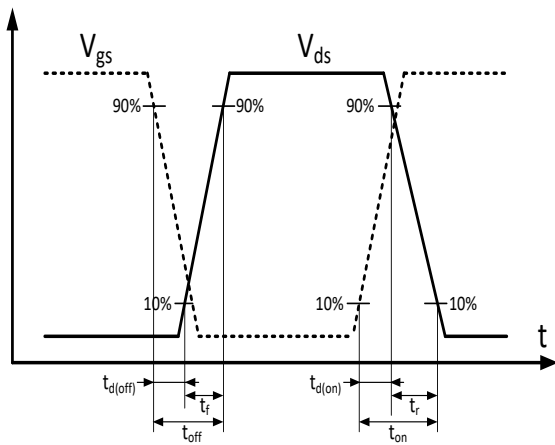
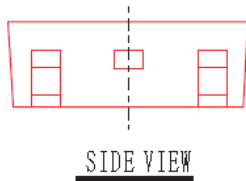
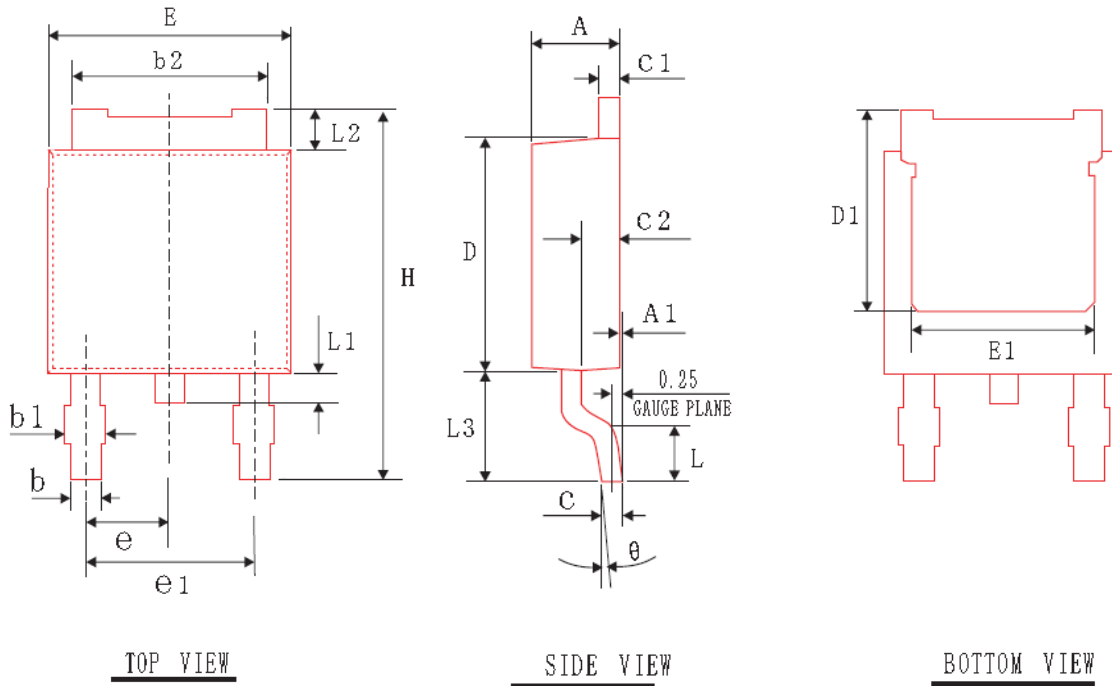

Figure 15. Switching times with waveform

PACKAGE DIMENSIONS

TO252-2L



COMMON DIMENSIONS
(UNITS OF MEASURE-mm)

| SYMBOL | MIN | NOM | MAX |
|----------|-----------|-------|-------|
| A | 2.20 | 2.30 | 2.40 |
| A1 | 0.00 | 0.05 | 0.10 |
| b | 0.762 | 0.812 | 0.862 |
| b1 | --- | --- | 1.10 |
| b2 | 5.23 | 5.33 | 5.43 |
| c | 0.458 | 0.508 | 0.558 |
| c1 | 0.458 | 0.508 | 0.558 |
| c2 | 0.80 | 1.00 | 1.20 |
| D | 6.00 | 6.10 | 6.20 |
| D1 | 5.25 | 5.45 | 5.65 |
| H | 10.00 | 10.10 | 10.20 |
| E | 6.50 | 6.60 | 6.70 |
| E1 | 4.75 | 4.85 | 4.95 |
| e1 | 4.37 | 4.57 | 4.77 |
| L | --- | --- | 1.45 |
| L1 | 0.60 | 0.75 | 0.90 |
| L2 | 0.90 | 1.10 | 1.30 |
| L3 | 2.80 | 3.00 | 3.20 |
| θ | 0° | 4° | 8° |
| e | 2.285 BSC | | |



Revision history

Major changes since the last revision

| Revision | Date | Description of changes |
|----------|------------|-------------------------------------|
| 1.0 | 2022-02-28 | Initial release |
| 2.0 | 2023-10-30 | Enrich dynamic specification curves |
| 3.0 | 2023-12-25 | Update dynamic parameters |