



CE65E300DNYI

CorEnergy 650V GaN HEMT

Description

The CE65E300DNYI Series 650V, 300mΩ gallium nitride (GaN) FETs are normally-off devices. Coreenergy GaN FETs offer better efficiency through lower gate charge, faster switching speeds, and smaller reverse recovery charge, delivering significant advantages over traditional silicon (Si) devices.

Coreenergy is a leading-edge wide band gap supplier with world-class innovation .

Application

- Fast charger
- Renewable energy
- Telecom and data-com
- Servo motors
- Industrial
- Automotive

General Features

Low conduction and switching losses no free-wheeling diode required RoHS compliant and Halogen-free

Benefits

Increased efficiency through fast switching
 Increased power density
 Reduced system size and weight

Ordering Information

Part Number	Package	Package Configuration
CE65E300DNYI	DFN(5*6)	Source

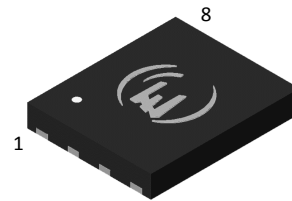

Top

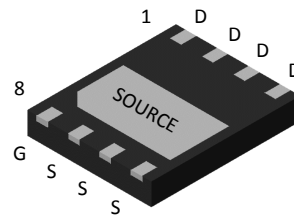

Bottom

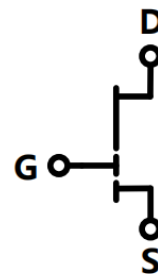

Circuit Symbol

Features

BV_{DSS}	$R_{DS(on)}$	I_{DS}	Q_G
650V	300mΩ	8A	1.35nC



Absolute Maximum Ratings

$T_j=25^{\circ}\text{C}$ unless otherwise stated

Symbol	Parameter	Limit value	Unit	
$V_{DS,max}$	Drain to source voltage($T_j=-55^{\circ}\text{C}$ to 150°C)	650	V	
$V_{DS(transient)}$	Drain to source voltage-transient ^a	750		
V_{GS}	Gate to source voltage	-10~+7		
I_D	Continuous drain current @ $T_c=25^{\circ}\text{C}^b$	8	A	
	Continuous drain current @ $T_c=125^{\circ}\text{C}^b$	3.5		
I_{DM}	Pulse drain current (pulse width: 300 μs) @ $T_c=25^{\circ}\text{C}$	11		
	Pulse drain current (pulse width: 300 μs) @ $T_c=125^{\circ}\text{C}$	6		
P_D	Maximum power dissipation @ $T_c=25^{\circ}\text{C}$	38	W	
T_C	Operating temperature	Case	-55~150	$^{\circ}\text{C}$
T_J		Junction	-55~150	$^{\circ}\text{C}$
T_S	Storage temperature	-55~150	$^{\circ}\text{C}$	

Notes:

a.Non-repetitive events, $T_{pulse} < 200\mu\text{s}$

b.For increased stability at high current operation



CE65E300DNYI

Thermal Resistance

Symbol	Parameter	Limit value	Unit
$R_{\theta JC}$	Junction-to-case	3.3	°C/W



Electrical Parameters

$T_j=25^\circ\text{C}$ unless otherwise stated

Symbol	Parameter	Min	Typ	Max	Unit	Test Conditions
Forward Device Characteristics						
$V_{(BL)DSS}$	Drain-source voltage	650	-	-	V	$V_{GS}=0V$
$V_{GS(th)}$	Gate threshold voltage	2	2.5	3	V	$I_D=10\mu\text{A}/\text{mm}$, $V_{DS}=1V$, $T_j=25^\circ\text{C}$
	Gate threshold voltage	-	2.8	-	V	$I_D=10\mu\text{A}/\text{mm}$, $V_{DS}=1V$, $T_j=150^\circ\text{C}$
$R_{DS(on)}$	Drain-source on resistance	-	300	360	m Ω	$V_{GS}=6V$, $I_D=1A$, $T_j=25^\circ\text{C}$
		-	660	-		$V_{GS}=6V$, $I_D=1A$, $T_j=150^\circ\text{C}$
I_{DSS}	Drain-to-source leakage current	-	1	10	μA	$V_{DS}=650V$, $V_{GS}=0V$, $T_j=25^\circ\text{C}$
		-	10	50		$V_{DS}=650V$, $V_{GS}=0V$, $T_j=150^\circ\text{C}$
I_{GSS}	Gate-to-source forward leakage current	-	60	-	μA	$V_{GS}=6V$, $V_{DS}=0V$
C_{ISS}	Input capacitance	-	46	-	pF	$V_{GS}=0V$, $V_{DS}=400V$, $f=1\text{MHz}$
C_{OSS}	Output capacitance	-	18	-		
C_{RSS}	Reverse capacitance	-	0.7	-		
$C_{o(er)}$	Effective output capacitance (energy related)	-	27	-	pF	$V_{GS}=0V$, $V_{DS}=0$ to 400V
$C_{o(tr)}$	Effective output capacitance (time related)	-	40	-	pF	$V_{GS}=0V$, $V_{DS}=0$ to 400V
Q_{OSS}	Output Charge	-	16	-	nC	$V_{GS}=0V$, $V_{DS}=0$ to 400V
Q_G	Total gate charge	-	1.35	-	nC	$V_{DS}=400V$, $V_{GS}=0$ to 6V, $I_D=1A$
Q_{GS}	Gate-source charge	-	0.15	-		
Q_{GD}	Gate-drain charge	-	0.5	-		
$t_{d(on)}$	Turn-on delay time	-	4.4	-	nS	$V_{DS}=400V$, $V_{GS}=0$ to 6V, $I_D=3A$ $R_{g_on(ext)}=6.8\Omega$ $R_{g_off(ext)}=2.2\Omega$, $L=250\mu\text{H}$
$t_{d(off)}$	Turn-off delay time	-	4.1	-		
t_r	Rise time	-	11.8	-		
t_f	Fall time	-	11.2	-		
Reverse Device Characteristics						
V_{SD}	Reverse voltage	-	3	-	V	$V_{GS}=0V$, $I_{SD}=3A$
Q_{RR}	Reverse recovery charge	-	0	-	nC	$I_{SD}=3A$, $V_{DS}=400V$



Electrical Characteristics

$T_j=25^\circ\text{C}$ unless otherwise stated

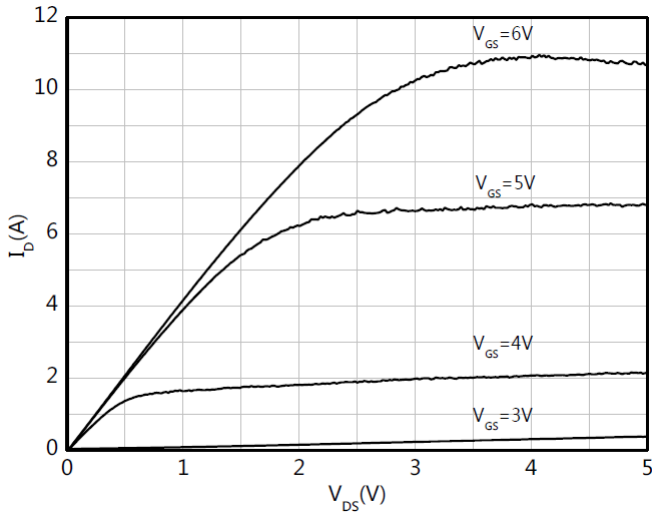

Figure 1. Typical Output Characteristics $T_j=25^\circ\text{C}$

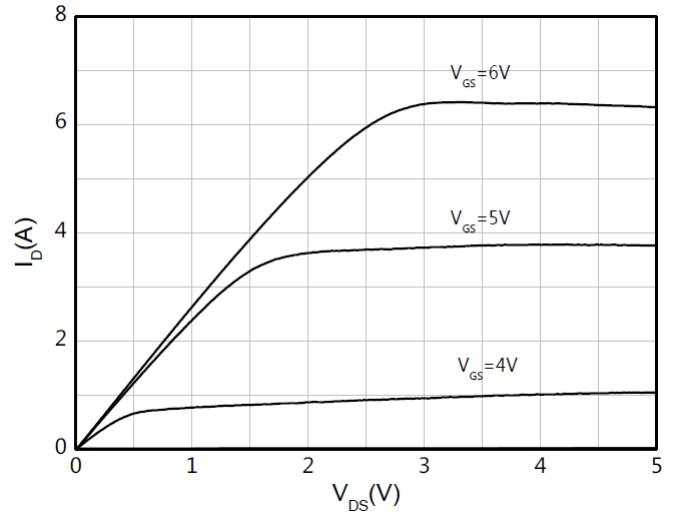

Figure 2. Typical Output Characteristics $T_j=125^\circ\text{C}$

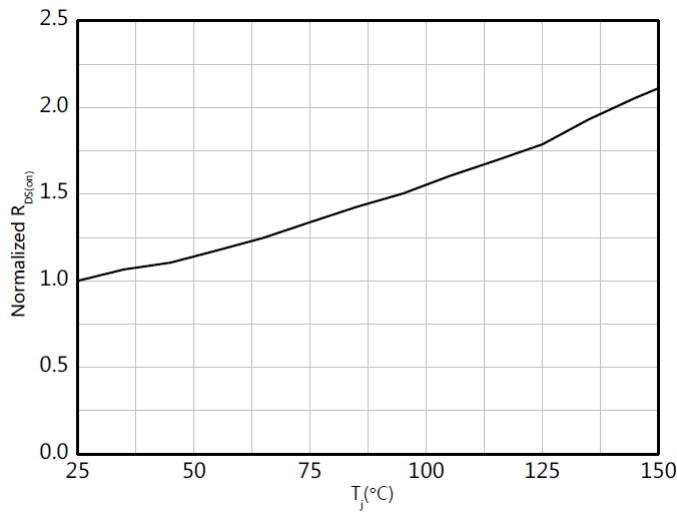

Figure 3. Drain-source On-state Resistance

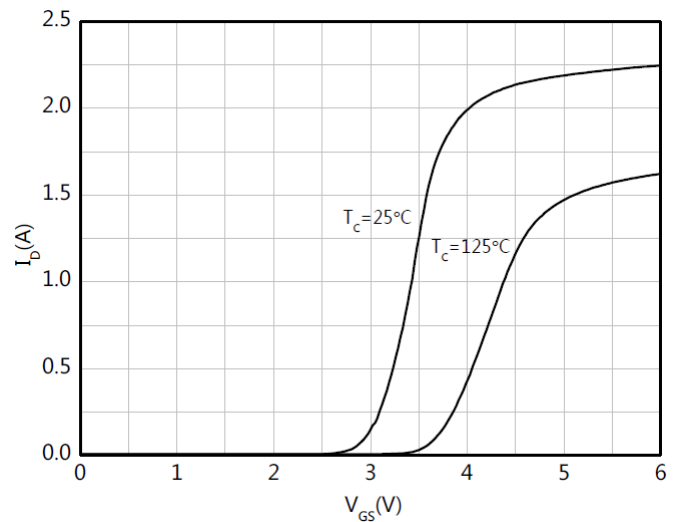

Figure 4. Typical Transfer Characteristics $V_{DS}=1\text{V}$



Electrical Characteristics

$T_j=25^\circ\text{C}$ unless otherwise stated

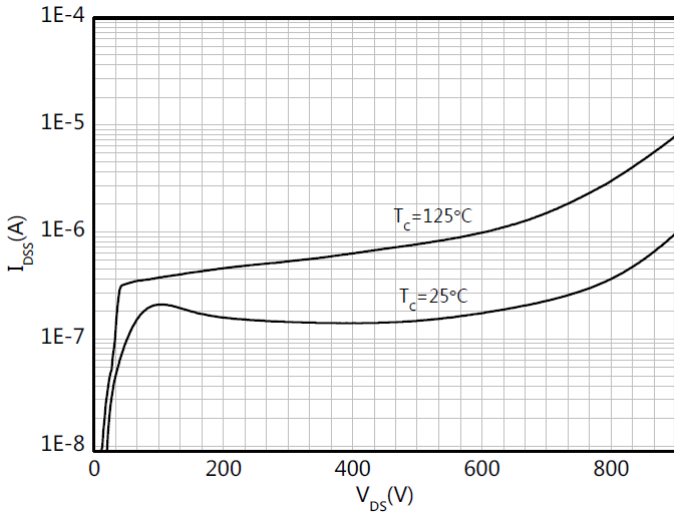

Figure 5. Drain-source Leakage Characteristics

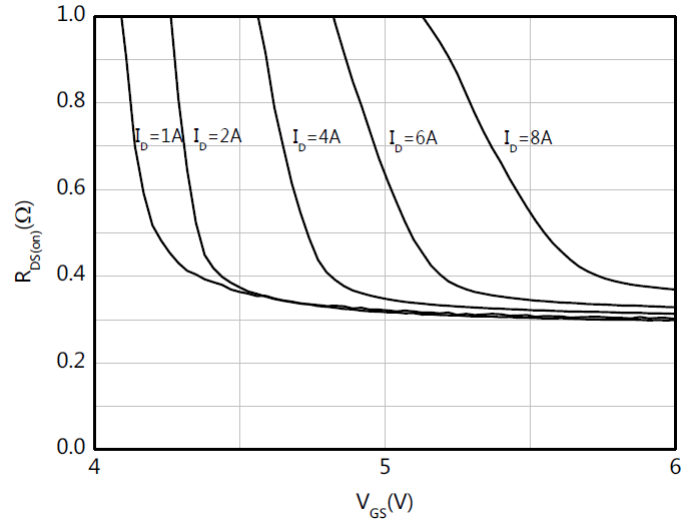

Figure 6. Typical On-state Resistance $T_j=25^\circ\text{C}$

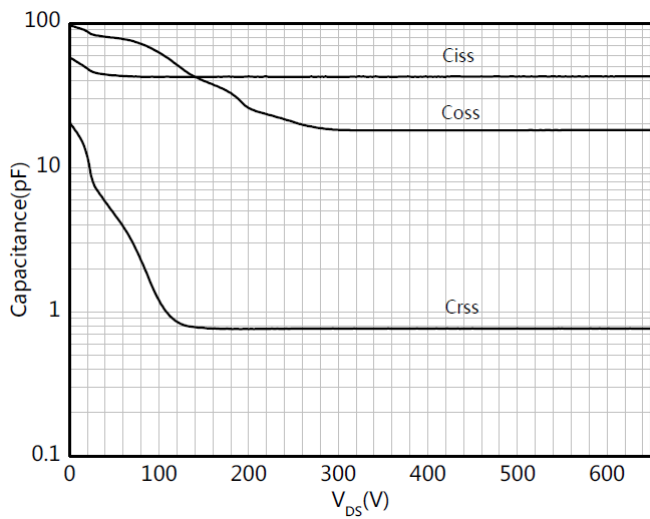

Figure 7. Typical Capacitance $f=1\text{MHz}$

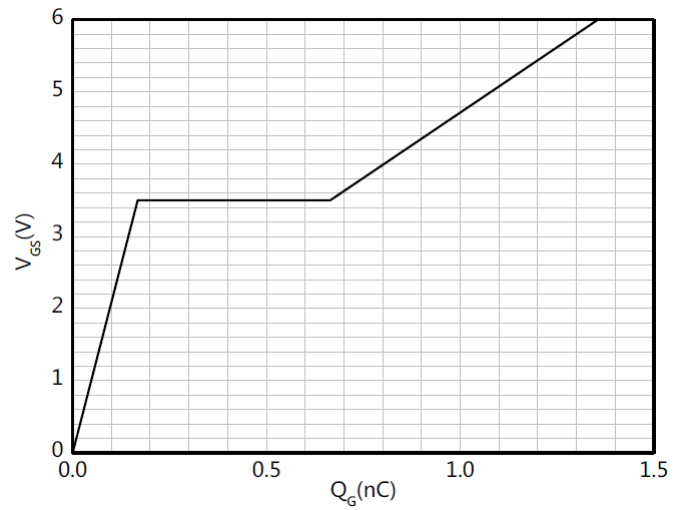

Figure 8. Typical Gate Charge ($V_{DS}=400\text{V}$, $I_D=1\text{A}$)



Electrical Characteristics

$T_J=25^\circ\text{C}$ unless otherwise stated

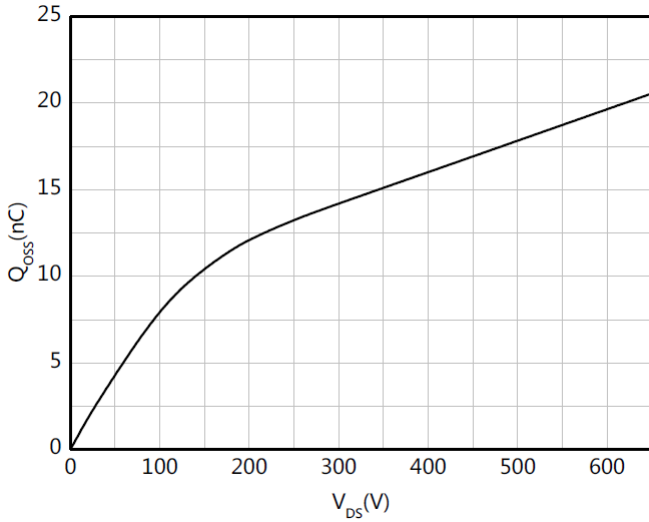

Figure 9. Typical Output Charge $f=1\text{MHz}$

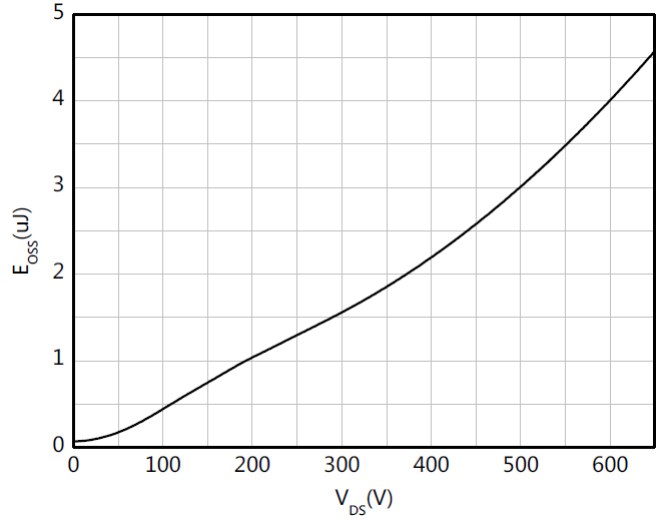

Figure 10. Typical Coss Stored Energy $f=1\text{MHz}$

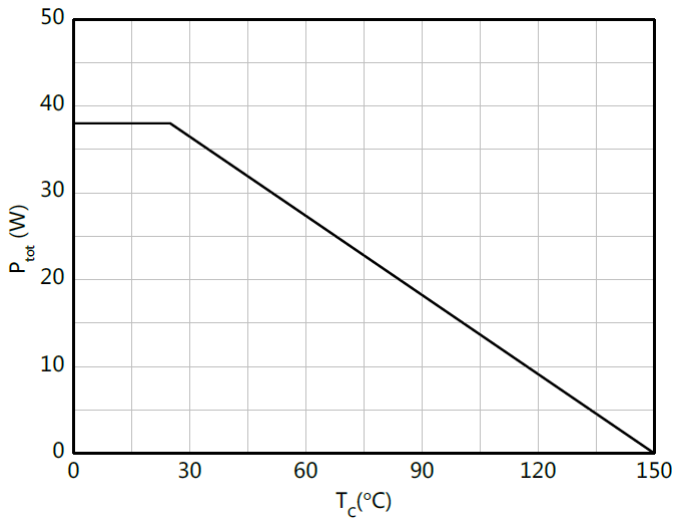

Figure 11. Power Dissipation

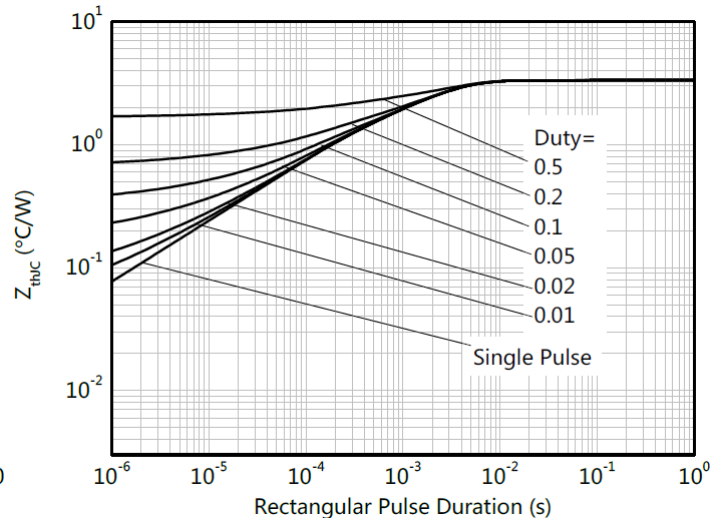

Figure 12. Transient Thermal Impedance

Electrical Characteristics

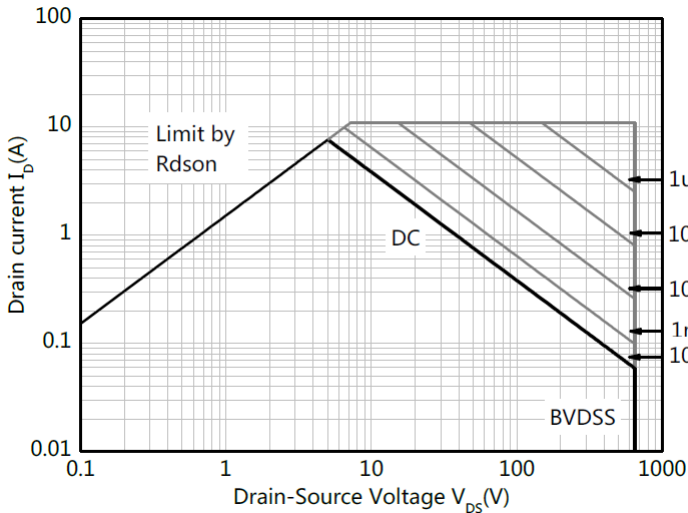

Figure 13. Safe Operation Area at $T_c=25^\circ\text{C}$

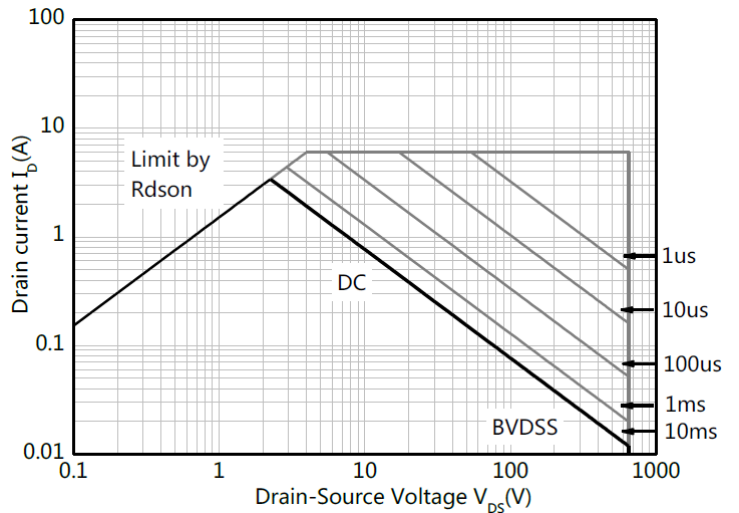

Figure 14. Safe Operation Area at $T_c=125^\circ\text{C}$

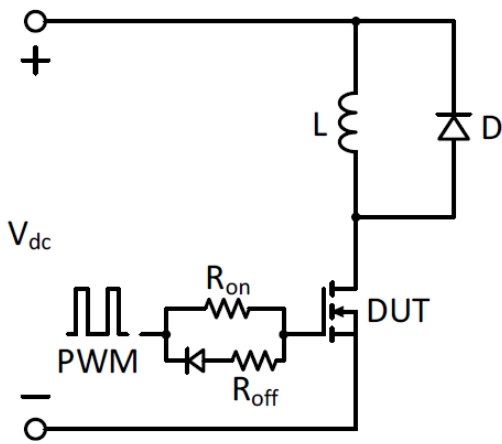

Figure 15. Switching Times With Inductive Load

$V_{DS}=400\text{V}$, $V_{GS}=0\text{V to }6\text{V}$, $I_D=3\text{A}$,
 $R_{G-on(ext)}=6.8\Omega$, $R_{G-off(ext)}=2.2\Omega$, $L=250\mu\text{H}$

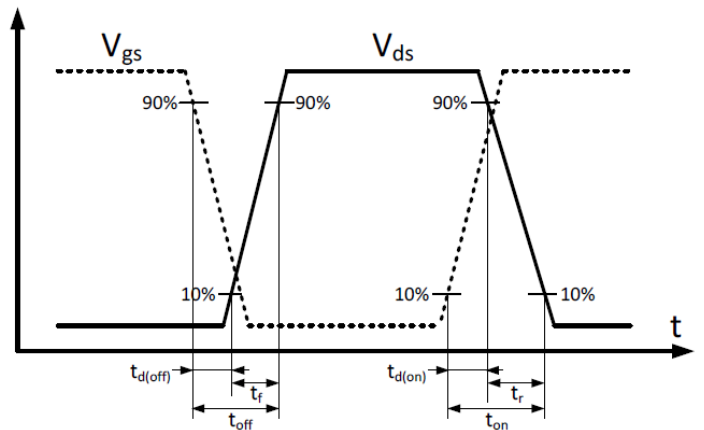
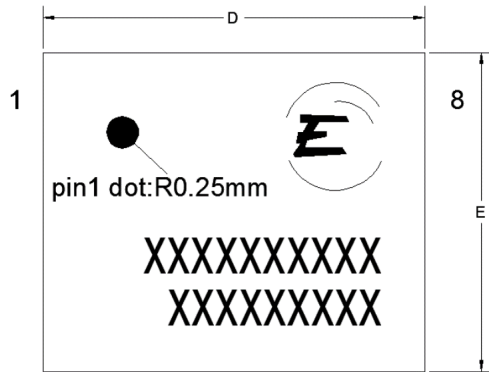

Figure 16. Switching Times With Waveform

PACKAGE DIMENSIONS

DFN5*6-8L-A

Top view



Bottom view

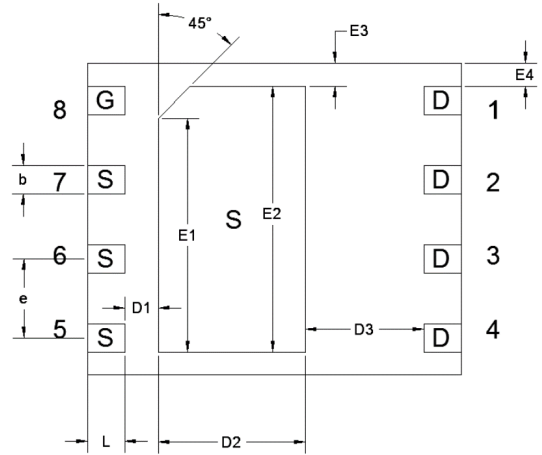

Side view(left/right)



Symbol	Min. (mm)	Mean. (mm)	Max. (mm)
A	0.85	0.90	0.95
A1	0	0.02	0.05
A2	0.203REF		
D	5.9	6	6.1
E	4.9	5	5.1
D1	0.43	0.53	0.63
D2	2.27	2.37	2.47
D3	1.8	1.9	2
E1	3.65	3.75	3.85
E2	4.16	4.26	4.36
E3	0.27	0.37	0.47
E4	0.27	0.37	0.47
b	0.4	0.45	0.5
e	1.17	1.27	1.37
L	0.5	0.6	0.7